

# VMP 2012|2013 CATALOG

VIDEO MOUNT PRODUCTS

Satellite & Antenna Mounts Flat Panel Mounts Digital Signage Mounts Projector Mounts Equipment Racks & Accessories



## NOTHING HOLDS UP BETTER

*Video Mount Products Mounting Systems For Video, Audio & Security... Nothing Holds Up Better*



## About VMP

Since 1994, Video Mount Products (VMP) has been chosen by video, audio, custom install, security industry professionals and consumers alike. VMP's unmatched designs, famed reliability, and long term durability have become a staple for mounting applications across a wide variety of industries. During the past decade, VMP has embraced the widely recognized flat panel revolution by quickly updating and continually launching new flat panel mounts and accessories to grow alongside these ever evolving segments of the consumer and professional A/V markets. In 2012, VMP continues to be recognized as the mounting systems company of choice for those discerning professionals who demand variety in a product mix as well as requiring dependable mounts and accessories. VMP mounting systems are capable of holding a large variety of flat panels while incorporating numerous tilt and swivel capabilities to meet the needs of any and every customer and installation. VMP has never forgotten its roots and we continually offer and update our wide variety of mounting systems and accessories that proudly serve as VMP's core product foundation launched more than 18 years ago.

Customer satisfaction is VMP's number one goal. All VMP mounting systems are manufactured from tempered high grade steel and use durable powder coat finishes. VMP products carry a **Forever Warranty** as well as offer peace of mind and simple, quick installation. If your installation includes flat panels, projectors, CCTV systems, equipment racks or satellite and antenna systems in commercial or residential applications, VMP has the mounting solution for you. We look forward to continually serving the professional A/V industry with the products they need and the reliability they have come to trust from VMP. After 18 years, we are still proud to say that "Nothing Holds Up Better!"

TOLL FREE [877.281.2169](tel:877.281.2169) >> TELEPHONE [410.643.6390](tel:410.643.6390) >> WEBSITE [VIDEOMOUNT.COM](http://VIDEOMOUNT.COM)

**NOTHING HOLDS UP BETTER**  
Video Mount Products Mounting Systems for Video, Audio & Security...Nothing Holds Up Better!



# Table of Contents

## 4 » Flat Panel Mounts

- 4 Flush Wall Mounts
- 6 Flush Wall Mounts with Tilt
- 8 Articulating Wall Mounts
- 10 Ceiling Mounts
- 12 Specialized Mounts
- 13 Dual Mount Adaptors
- 14 Flat Panel Mount Adaptors

## 16 » Digital Signage Mounts & Accessories

## 18 » Projector Mounts

## 20 » Equipment Racks & Accessories

- 20 Racks
- 22 Shelves
- 25 Rack Accessories

## 28 » Security Mounts

## 30 » Mounting Accessories

## 36 » Satellite & Antenna Mounts & Accessories

## 40 » DLP Mounts & Turntables

## 41 » Speaker Mounts

## 42 » Resources & Index



NEED HELP CHOOSING THE RIGHT MOUNT FOR YOUR APPLICATION? [WWW.CHOOSEAMOUNT.COM](http://WWW.CHOOSEAMOUNT.COM)

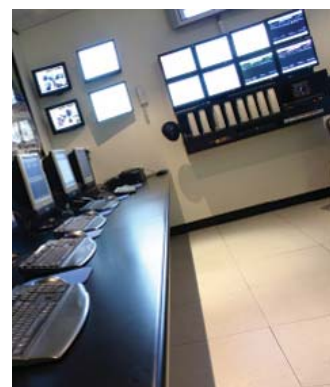

**WARNING** The installer of these products must verify that the mounting surface, ceiling or wall, will safely support the combined weight of all attached equipment and hardware. Video Mount Products will not be held liable for the improper use or installation of its products.

# Flat Panel Mounts

## Flush Wall Mounts

Flat Panel Mounts Digital Signage Mounts Projector Mounts Equipment Racks & Accessories Security Mounts Satellite & Antenna Mounts DLP Mounts & Turntables Speaker Stands

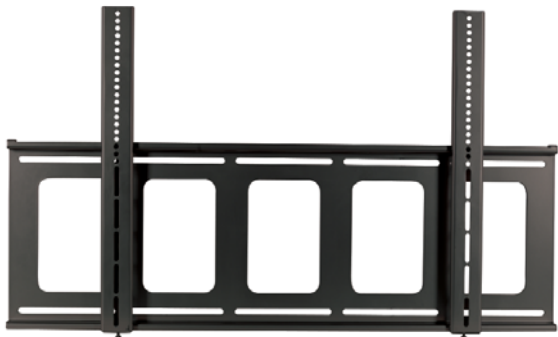

### FP-LFB *Large Flat Panel Flush Mount*

- Holds 42" – 70" flat panels
- Distance from wall to the back of the flat panel - 1.4"
- Maximum flat panel hole pattern – 850mm x 500mm
- Accommodates double gang box
- Load capacity – 180 lbs
- Black powder coat finish

FP-LF *Same as above except with silver finish*



### FP-LFVB

#### *Large Flat Panel Flush Mount - Open Architecture Design*

- Holds 42" – 63" flat panels
- Maximum flat panel hole pattern – 890mm x 540mm
- Distance from wall to back of the flat panel – 0.85"
- Load capacity – 150 lbs
- Black powder coat finish

FP-LFV *Same as above except with silver finish*

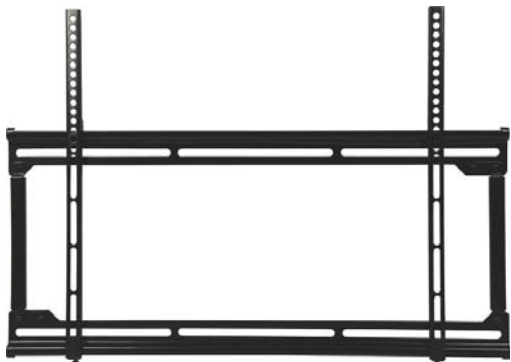

### FP-XMFB

#### *Extra Medium Flat Panel Flush Mount- Open Architecture Design*

- Holds 32" – 52" flat panels
- Maximum flat panel hole pattern – 640mm x 430mm
- Distance from wall to back of the flat panel – 0.85"
- Load capacity – 150 lbs
- Black powder coat finish

FP-XMF *Same as above except with silver finish*

**LCD-MID-FB** *Mid-Size Flat Panel Flush Mount*

- Holds 27" – 42" flat panels
- Maximum flat panel hole pattern – 410mm x 340mm
- Distance from wall to back of the flat panel – 1"
- Accommodates double gang box
- Load capacity – 125 lbs
- Black powder coat finish

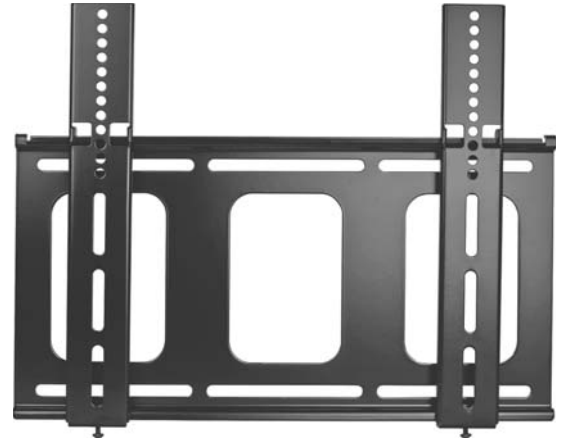
**LCD-MID-F** *Same as above except with silver finish***FP-MFB***Mid-Size Flat Panel Flush Mount -  
Open Architecture Design*

- Holds 27" – 42" flat panels
- Maximum flat panel hole pattern – 440mm x 330mm
- Distance from wall to back of the flat panel – 0.7"
- Load capacity – 100 lbs
- Black powder coat finish

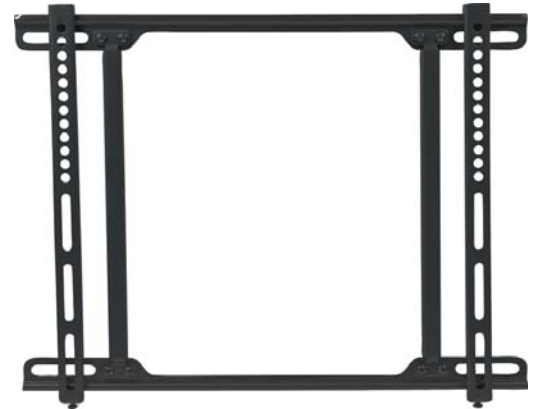
**FP-MF** *Same as above except with silver finish***FP-SFB** *Small Flat Panel Flush Mount*

- Holds 10" – 30" flat panels
- Accommodates flat panels with 75, 100, 200 and 100 x 200mm VESA hole patterns
- Quick connect/disconnect design
- Distance from wall to back of the flat panel – 0.5"
- Utilizes tamper resistant screws to provide extra security
- Load capacity – 50 lbs
- Black powder coat finish

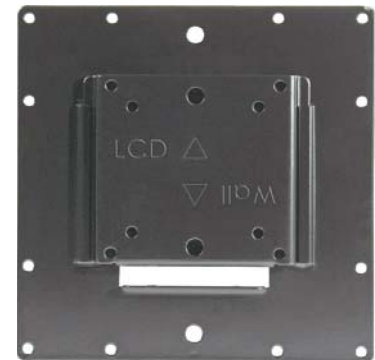

# Flat Panel Mounts

## Flush Wall Mounts with Tilt

Flat Panel Mounts Digital Signage Mounts Projector Mounts Equipment Racks & Accessories Security Mounts Satellite & Antenna Mounts DLP Mounts & Turntables Speaker Stands

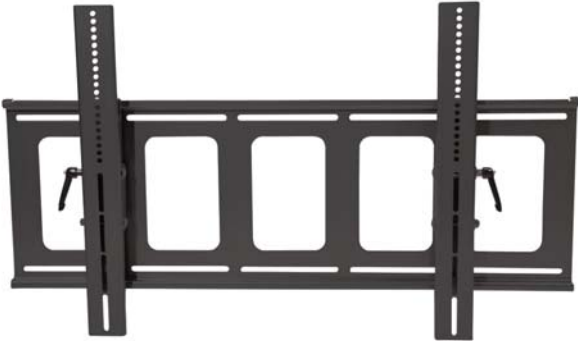

### **PDS-LFTB** *Large Flat Panel Flush Mount With Tilt*

- Holds 42" – 70" flat panels
- Maximum flat panel hole pattern – 850mm x 530mm
- Adjustable -5° to +15° tilt
- Distance from wall to back of the flat panel – 2.6"
- Load capacity – 180 lbs
- Black powder coat finish

**PDS-LFT** *Same as above except with silver finish*



### **FP-LDSB** *Large Flat Panel Digital Signage Mount*

- Holds 32" – 63" flat panels in portrait or landscape
- Maximum flat panel hole pattern – 810mm x 530mm (810mm x 810mm with included extensions)
- Adjustable -5° to +15° tilt lockable in 5° increments
- Sectional wall plate can be integrated with multiple FP-LDSB's to create a video wall using DS-BP (For more information on DS-BP see pg.16)
- Distance from wall to back of the flat panel – 2.5" (2.6" with extensions)
- Load capacity – 180 lbs
- Black powder coat finish



### **FP-XMFTB**

#### *Extra Medium Flat Panel Flush Mount With Tilt*

- Holds 32" – 52" flat panels
- Maximum flat panel hole pattern – 616mm x 400mm
- Adjustable -5° to +15° tilt
- Distance from wall to back of the flat panel – 2.3"
- Load capacity – 120 lbs
- Black powder coat finish

**FP-XMFT** *Same as above except with silver finish*

**FP-MFTB***Multi-Just™ Mid-Size Flat Panel Flush Mount With Tilt*

- Holds 27" – 42" flat panels
- Maximum flat panel hole pattern – 415mm x 345mm
- Adjustable -5° to +15° tilt
- Vertical height adjustment – 1"
- List adjustment – ±3°
- Installer friendly kickstand
- Distance from wall to back of the flat panel – 2.3"
- Load capacity – 100 lbs
- Black powder coat finish

**LCD-MID-FTB** *Mid-Size Flat Panel Flush Mount With Tilt*

- Holds 27" – 42" flat panels
- Maximum flat panel hole pattern – 410mm x 340mm
- Distance from wall to back of the flat panel – 2.4"
- Adjustable -5° to +15° tilt
- Accommodates double gang box
- Load capacity – 100 lbs
- Black powder coat finish



**LCD-MID-FT** *Same as above except with silver finish*

**FP-SFTB** *Small Flat Panel Flush Mount With Tilt*

- Holds 10" – 23" flat panels
- Accommodates flat panels with 75 or 100mm VESA hole patterns
- Adjustable -5 to +15° tilt
- Distance from wall to back of the flat panel – 1.7"
- Utilizes tamper resistant hardware
- Load capacity – 25 lbs
- Black powder coat finish



**FP-SFT** *Same as above except with silver finish*



# Flat Panel Mounts

## Articulating Wall Mounts

Flat Panel Mounts Digital Signage Mounts Projector Mounts Equipment Racks & Accessories Security Mounts Satellite & Antenna Mounts DLP Mounts & Turntables Speaker Stands



### **PDS-LWAB** *Large Flat Panel Articulating Wall Mount*

- Holds 42" – 70" flat panels
- Maximum flat panel hole pattern – 950mm x 530mm
- Rotates 45° and has adjustable -5° to +15° tilt
- Depth 4" (Arms fully collapsed)
- Depth 24" (Arms fully extended)
- Includes cable management covers
- Load capacity - 180 lbs
- Black powder coat finish

**PDS-LWA** *Same as above except with silver finish*



### **FP-XMWAB**

#### *Extra Medium Flat Panel Articulating Wall Mount*

- Holds 32" – 52" flat panels
- Maximum flat panel hole pattern – 800mm x 500mm
- Rotates 45° and has adjustable 0° to 15° tilt
- List adjustment –  $\pm 3^\circ$
- Depth 5.3" (arms fully collapsed)
- Depth 16.3" (arms fully extended)
- Mounting rails accept padlocks
- Clip based cable management system
- Load capacity - 130 lbs
- Black powder coat finish



### **FP-MWAB**

#### *Mid-Size Flat Panel Articulating Wall Mount*

- Holds 24" – 37" flat panels
- Maximum flat panel hole pattern – 450mm x 400mm
- Rotates 45° and has adjustable  $\pm 15^\circ$  tilt
- List adjustment –  $\pm 3^\circ$
- Depth 5.5" (arms fully collapsed)
- Depth 16.5" (arms fully extended)
- Mounting rails accept padlocks
- Clip based cable management system
- Load capacity - 80 lbs
- Black powder coat finish



### LCD-2537B

*Multi-Configurable Mid-Size Flat Panel  
Articulating Wall Mount*

- Holds 25" – 32" flat panels
- Can be configured as a single arm, double arm or near flush mount with parts provided
- Accommodates flat panels with 75, 100, 200 and 100 x 200mm VESA hole patterns
- Adjustable -5° to +20° tilt
- Rotates 240° at the elbow joint (double arm configuration)
- Rotates 160° at the wall / Rotates 240° at the panel
- Feed through wall plate with decorative cover
- Clip based cable management system
- Load capacity - 50 lbs
- Black powder coat finish

**LCD-2537** *Same as above except with silver finish*



### LCD-1B

*Multi-Configurable Small Flat Panel  
Articulating Wall Mount*

- Holds 10" – 23" flat panels
- Can be configured as a single arm, double arm or near flush mount with parts provided
- Accommodates flat panels with 75 or 100mm VESA hole patterns
- Adjustable -5° to +20° tilt
- Rotates 240° at the elbow joint (double arm configuration)
- Rotates 160° at the wall / Rotates 240° at the panel
- Feed through wall plate with decorative cover
- Clip based cable management system
- Load capacity - 25 lbs
- Black powder coat finish

**LCD-1** *Same as above except with silver finish*



#### Multi-Configuration Options



# Flat Panel Mounts

## Ceiling Mounts

Flat Panel Mounts Digital Signage Mounts Projector Mounts Equipment Racks & Accessories Security Mounts Satellite & Antenna Mounts DLP Mounts & Turntables Speaker Stands



### PDS-LCB *Large Flat Panel Ceiling Mount*



- Holds 37" - 70" flat panels
- Maximum flat panel hole pattern – 860mm x 500mm
- Mast telescopes 23" – 35"
- Rotates 360° / Adjustable 0° – 15° tilt
- Cable management through the center of the mast
- Load capacity - 180 lbs
- Black powder coat finish

**PDS-LC** *Same as above except with silver finish*



### LCD-MID-CB *Mid-Size Flat Panel Ceiling Mount*



- Holds 27" – 42" flat panels
- Maximum flat panel hole pattern – 410mm x 340mm
- Mast telescopes 23" – 35"
- Rotates 360° / Adjustable -5° to +20° tilt
- Cable management through the center of the mast
- Load capacity – 100 lbs
- Black powder coat finish

**LCD-MID-C** *Same as above except with silver finish*



### LCD-MID-CHB

#### *Mid-Size Flat Panel Ceiling Mount - Head Only*



- Holds 27" – 42" flat panels
- Maximum flat panel hole pattern - 410mm x 340mm
- Rotates 360° / Adjustable -5° to +20° tilt
- Uses standard 1.5" NPT masting
- Load capacity – 100 lbs
- Black powder coat finish

### LCD-2537CB *Mid-Size Flat Panel Ceiling Mount*

- Holds 25" – 37" flat panels
- Accommodates flat panels with 75, 100, 200 and 100 x 200 mm VESA hole patterns
- Mast telescopes 18" – 30"
- Rotates 360° (mast) / Rotates 240° (panel)
- Adjustable -5° to +20° tilt
- Includes clip based cable management system
- Load capacity - 75 lbs
- Black powder coat finish

**LCD-2537C** *Same as above except with silver finish*



### LCD-1CB *Small Flat Panel Ceiling Mount*

- Holds 10" – 23" flat panels
- Accommodates flat panels with 75 or 100 mm VESA hole patterns
- Mast telescopes 17" – 27"
- Rotates 360° (mast) / Rotates 240° (panel)
- Adjustable -5° to +20° tilt
- Includes clip based cable management system
- Load capacity - 25 lbs
- Black powder coat finish

**LCD-1C** *Same as above except with silver finish*

**LCD-1CW** *Same as above except with white finish*



# Flat Panel Mounts

## Specialized Mounts

Flat Panel Mounts Digital Signage Mounts Projector Mounts Equipment Racks & Accessories Security Mounts Satellite & Antenna Mounts DLP Mounts & Turntables Speaker Stands



### ER-LCD1017 *LCD Monitor Rack Mount*



- Holds monitors 10" – 17" or can be inverted to hold monitors up to 23" / Recesses monitor into rack
- Accommodates monitors with 75mm and 100mm VESA hole patterns / 9 space racking height
- Includes 10-32 and 12-24 rack screws
- Load capacity - 50 lbs
- Black static resistant powder coat finish



### LCD-2B *Small Flat Panel Table/Desk Mount*



- Holds 10" – 23" flat panels
- Accommodates flat panels with 75 or 100mm VESA hole patterns
- Rotates 360° at base / Adjustable -5° to +30° tilt
- Force arm has adjustable 0° to 60° forward tilt
- Can be attached as a clamp-on or bolt through mount with parts provided
- Load capacity - 25 lbs / Black powder coat finish

**LCD-2** *Same as above except with silver finish*



### LCD-UC1 *LCD Under Cabinet Mount*



- Holds 10"– 17" flat panels
- Accommodates flat panels with 75 or 100mm VESA hole patterns
- Can be flipped up to store LCD when not in use
- 360° swivel for optimum viewing
- Load capacity – 20 lbs / Silver powder coat finish

*NOTE: Cabinet depth may limit screen size*



### TT-LCD20B *Flat Panel Turntable*



- Platform width 20" / Platform depth 14"
- Load capacity – 75 lbs / Black finish

**TT-LCD20S** *Same as above except with silver finish*



### PDS-LCM2B

#### Dual Large Flat Panel Ceiling Mount Adaptor

- Holds 37" – 70" flat panels
- Adapts PDS-LCB (sold separately) to accommodate 2 flat panels
- Maximum flat panel hole pattern – 860mm x 500mm
- Rotates 360° / Adjustable 0° – 15° tilt
- Combined load capacity of PDS-LCB and PDS-LCM2B – 380 lbs
- Black powder coat finish



Shown with PDS-LCB (not included)

### LCD-MID-CM2B

#### Dual Mid-Size Flat Panel Ceiling Mount Adaptor

- Holds 27" – 42" flat panels
- Adapts LCD-MID-CB (sold separately) to accommodate 2 flat panels
- Maximum flat panel hole pattern – 410mm x 340mm
- Adjustable -5° to +20° tilt
- Combined load capacity of LCD-MID-CB and LCD-MID-CM2B – 200 lbs
- Black powder coat finish



Shown with LCD-MID-CB (not included)

**LCD-MID-CM2** Same as above except with silver finish

### LCD-CM2

#### Dual Small Flat Panel Ceiling Mount Adaptor

- Holds 10" – 23" flat panels
- Adapts LCD-1C (sold separately) to accommodate 2 flat panels with 75 or 100mm VESA hole patterns
- Adjustable -5° to +20° tilt / Rotates 240° at flat panel
- Combined load capacity of LCD-CM2 and LCD-1C - 50 lbs
- Silver powder coat finish



Shown with LCD-1C (not included)



# Flat Panel Mounts

## Dual Mount Adaptors

Flat Panel Mounts Digital Signage Mounts Projector Mounts Equipment Racks & Accessories Security Mounts Satellite & Antenna Mounts DLP Mounts & Turntables Speaker Stands

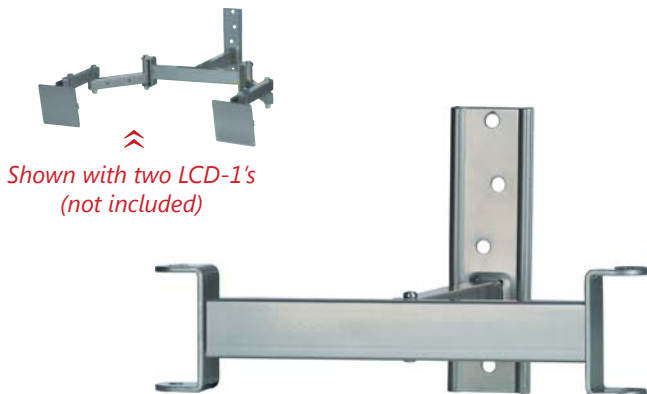

### LCD-WM2 *Dual Small Flat Panel Wall Mount Adaptor*

- Allows attachment of two LCD-1's (sold separately) to create side by side viewing
- Arm extends 11" from wall
- Load capacity - 50 lbs
- Silver powder coat finish

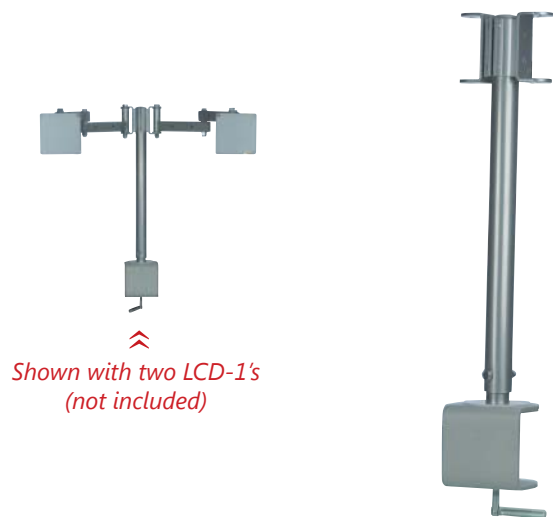

### LCD-DM2 *Dual Small Flat Panel Desk Mount Adaptor*

- Allows attachment of two LCD-1 mounts (sold separately) to create side by side viewing
- Can be attached as a clamp-on or bolt through mount (with parts provided)
- Mounting pole telescopes from 18" - 24"
- Load capacity - 50 lbs
- Silver powder coat finish

## Flat Panel Mount Adaptors



### AP-1B *400mm x 200mm VESA Adaptor Plate*

- Adapts a VESA 200mm plate to accommodate a VESA 400mm x 200mm hole pattern
- Black powder coat finish

**AP-1** *Same as above except with silver finish*

### AP-2B 300mm x 300mm VESA Adaptor Plate

- Adapts a VESA 200mm plate to accommodate a VESA 300mm x 300mm hole pattern
- Black powder coat finish



### AR-1B Portrait Mounting Adaptor Rails

- Adapts a wide variety of mounting rails to accept a maximum of 650mm vertical hole patterns
- Black powder coat finish

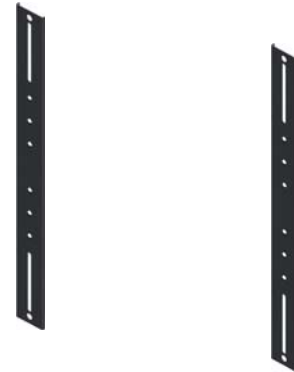

### IWB-1B In Wall Box or Adaptor

- Can be used as a pre-construction or retro-fit in wall box or in conjunction with the LCD-1B or the LCD-2537B for a "No Profile" flat panel installation
- Holds 15" – 32" flat panels
- Installs between 16" centers
- Integrated cable (4) and electrical knockouts (2)
- Includes black adaptors for the LCD-1B and LCD-2537B
- Load capacity – 50 lbs

**IWB-1** Same as above except with silver adaptors



### LCD-PA Pole Adaptor

- For use with LCD-1 and LCD-2537
- Adapts round or square poles to accept mount
- Stainless steel straps adjust from 4" – 10"
- Silver powder coat finish



# Digital Signage Mounts & Accessories

Flat Panel Mounts **Digital Signage Mounts** Projector Mounts Equipment Racks & Accessories Security Mounts Satellite & Antenna Mounts DLP Mounts & Turntables Speaker Stands



## **FP-LDSB** *Large Flat Panel Digital Signage Mount*

- Holds 32" – 63" flat panels in portrait or landscape
- Maximum flat panel hole pattern – 810mm x 530mm (810mm x 810mm with included extensions)
- Adjustable -5° to +15° tilt lockable in 5° increments
- Sectional wall plate can be integrated with multiple FP-LDSB's to create a video wall using DS-BP
- Distance from wall to back of the flat panel – 2.5" (2.6" with extensions)
- Load capacity – 180 lbs
- Black powder coat finish



## **DS-CH** *Digital Signage Computer or Component Holder*

- Used to securely attach a digital signage computer or other component to a wall or ceiling mount
- Attaches to mounting rails in landscape or portrait positions to better hide behind the flat panel
- Utilizes tamper resistant hardware
- Works with VMP models FP-LDSB, PDS-LC and PDS-LFT as well as other manufacturers' mounts
- Interior dimensions – 11" x 7" x 2.375"
- Black powder coat finish



## **DS-BP** *FP-LDSB Wall Plate Extension*

- Used with the FP-LDSB to extend the wall plate 12" to add additional flat panels / Black powder coat finish



## **PDS-LCB** *Large Flat Panel Ceiling Mount*

- Holds 37" - 70" flat panels
- Maximum flat panel hole pattern – 860mm x 500mm
- Mast telescopes 23" – 35"
- Rotates 360° / Adjustable 0° – 15° tilt
- Cable management through the center of the mast
- Load capacity - 180 lbs
- Black powder coat finish

**PDS-LC** *Same as above except with silver finish*



## PDS-LCM2B

### Dual Large Flat Panel Ceiling Mount Adaptor

- Holds 37" – 70" flat panels
- Adapts PDS-LCB (sold separately) to accommodate 2 flat panels
- Maximum flat panel hole pattern – 860mm x 500mm
- Rotates 360° / Adjustable 0° – 15° tilt
- Combined load capacity of PDS-LCB and PDS-LCM2B – 380 lbs
- Black powder coat finish



## LCD-MID-CB Mid-Size Flat Panel Ceiling Mount

- Holds 27" – 42" flat panels
- Maximum flat panel hole pattern – 410mm x 340mm
- Mast telescopes 23" – 35"
- Rotates 360° / Adjustable -5° to +20° tilt
- Cable management through the center of the mast
- Load capacity – 100 lbs
- Black powder coat finish

**LCD-MID-C** Same as above except with silver finish



## LCD-MID-CM2B

### Dual Mid-Size Flat Panel Ceiling Mount Adaptor

- Holds 27" – 42" flat panels
- Adapts LCD-MID-CB (sold separately) to accommodate 2 flat panels
- Maximum flat panel hole pattern – 410mm x 340mm
- Adjustable -5° to +20° tilt
- Combined load capacity of LCD-MID-CB and LCD-MID-CM2B – 200 lbs
- Black powder coat finish

**LCD-MID-CM2** Same as above except with silver finish



# Projector Mounts

Flat Panel Mounts Digital Signage Mounts **Projector Mounts** Equipment Racks & Accessories Security Mounts Satellite & Antenna Mounts DLP Mounts & Turntables Speaker Stands



## **PM-3** *Yokeless Projector Mount*

- Fits projectors with mounting holes inside 14.5" dia.
- Adjustable tilt -  $\pm 20^\circ$  / Adjustable pitch -  $\pm 15^\circ$
- Adjustable yaw (rotation) -  $\pm 180^\circ$  (360°)
- Mast telescopes 18" – 30"
- Flush mount plate and mounting screws included
- Load capacity - 75 lbs / Silver powder coat finish

**PM-3B** *Same as above except with black finish*



## **PM-LP**

### *Yokeless Low Profile Projector Mount With Cable Pass-Through*

- Fits projectors with mounting holes inside 14.5" dia.
- Low 2.625" profile (includes the mounting feet)
- Adjustable tilt -  $\pm 20^\circ$  / Adjustable pitch -  $\pm 15^\circ$
- Adjustable yaw (rotation) -  $\pm 180^\circ$  (360°)
- 1.5" NPT mast telescopes 23" – 35"
- Cable management through the center of the mast
- Flush mount plate and mounting screws included
- Load capacity - 75 lbs / Silver powder coat finish

**PM-LPB** *Same as above except with black finish*



## **PM-LPM** *Yokeless Low Profile Projector Mount*

- Fits projectors with mounting holes inside 14.5" dia.
- Low 2.625" profile (includes the mounting feet)
- Adjustable tilt -  $\pm 20^\circ$  / Adjustable pitch -  $\pm 15^\circ$
- Adjustable yaw (rotation) -  $\pm 180^\circ$  (360°)
- Cable management through the center of the mount
- Ceiling plate and mounting screws included
- Accepts standard 1.5" NPT masting
- Load capacity - 75 lbs / Silver powder coat finish

**PM-LPMB** *Same as above except with black finish*

## PM-2 *Small Clamping Projector Mount*



- Adjustable 0° to 10° tilt / Adjustable yaw (rotation) - 360°
- Opens from 7" to 13" (left to right)
- Opens from 3" to 5.75" (top to bottom)
- Mast telescopes 18" – 30"
- Eight-point clamping mechanism adjusts from 6.5" to 10" front to back
- Flush mount plate and mounting hardware included
- Load capacity - 75 lbs / Black powder coat finish



## PM-1 *Large Clamping Projector Mount*



- Adjustable 0° to 10° tilt / Adjustable yaw (rotation) - 360°
- Opens from 10" to 24" (left to right)
- Opens from 4.5" to 7.75" (top to bottom)
- Mast telescopes 18" – 30"
- Eight-point clamping mechanism adjusts from 8" to 11.75" front to back
- Integrated flush mount plate and mounting hardware included
- Load capacity - 75 lbs / Black powder coat finish



## PMC-S *Small Projector Enclosure*

- Inner dimensions - 16"W x 16"D x 10"H
- Lift off lid for installation
- Easy access hinge for maintenance
- Utilizes tamper resistant screws (included)
- Adjustable front security bars for lens placement
- Accommodates PM-2, PM-3B and PM-LPB
- Black powder coat finish



*Projector not included*



## PMC-L *Large Projector Enclosure*

- Inner dimensions - 24"W x 20"D x 13"H
- Lift off lid for installation
- Easy access hinge for maintenance
- Utilizes tamper resistant screws (included)
- Adjustable front security bars for lens placement
- Accommodates PM-1, PM-3B and PM-LPB
- Black powder coat finish



# Equipment Racks & Accessories

## Racks

Flat Panel Mounts Digital Signage Mounts Projector Mounts **Equipment Racks & Accessories** Security Mounts Satellite & Antenna Mounts DLP Mounts & Turntables Speaker Stands



### ER-1 19" Headend Equipment Rack – 71" Height



- Rail height – 71"
- 40 rack spaces
- EIA compliant
- Standard 10-32 threading
- Includes 32 rack screws
- Steel construction
- Load capacity – 400 lbs evenly distributed
- Black static resistant powder coat finish

### Assembly



### ER-1-4PKIT 2 Post Expansion Kit For ER-1



- Standard 10-32 threading in expansion posts
- Includes side stabilizing bars
- Steel construction
- Black static resistant powder coat finish



### ER-148 19" Headend Equipment Rack – 48" Height



- Rail height – 48" / 27 rack spaces
- EIA compliant
- Standard 10-32 threading / Includes 32 rack screws
- Steel construction
- Load capacity – 400 lbs evenly distributed
- Black static resistant powder coat finish



### ER-184 19" Headend Equipment Rack – 84" Height

- Rail height – 84"
- 45 rack spaces
- EIA compliant
- Standard 10-32 threading
- Includes 32 rack screws
- Steel construction
- Load capacity – 400 lbs evenly distributed
- Black static resistant powder coat finish



### ER-184-4PKIT 2 Post Stabilization Kit For ER-184

- Provides additional weight stabilization for ER-184
- Includes side stabilizing bars
- Steel construction
- Black static resistant powder coat finish



#### Assembly



### ER-W24 Swing Gate Wall Rack – 24" Height

- 13 rack spaces / EIA compliant
- Usable depth - 19"
- Opens from either the left or the right side
- Fixed wall plate allows easy installation and removal of populated rack
- Innovative lift on/off design allows for one man install
- Standard 10-32 threading
- Steel and aluminum construction
- Load capacity – 100 lbs evenly distributed
- Black static resistant powder coat finish



# Equipment Racks & Accessories

## Racks & Shelves

Flat Panel Mounts Digital Signage Mounts Projector Mounts **Equipment Racks & Accessories** Security Mounts Satellite & Antenna Mounts DLP Mounts & Turntables Speaker Stands



### ER-72 19" Aluminum Open Frame Rack - 72" Height

- 38 rack spaces
- EIA compliant
- Aluminum construction / Self squaring design
- Standard 10 – 32 threading
- Includes 32 rack screws
- Load capacity – 750 lbs evenly distributed
- Black powder coat finish



### ER-84 19" Aluminum Open Frame Rack - 84" Height

- 45 rack spaces
- EIA compliant
- Aluminum construction / Self squaring design
- Standard 10 – 32 threading
- Includes 32 rack screws
- Load capacity – 750 lbs evenly distributed
- Black powder coat finish

## Equipment Rack Shelves



### ER-S1 Economy Rack Shelf

- Fits components up to 17" wide
- Two space racking height (2.6") / Tray Depth - 12.5"
- Includes 10-32 and 12-24 mounting screws
- Load capacity – 40 lbs
- Black powder coat finish



### ER-S1V Vented Economy Rack Shelf

- Fits components up to 17" wide
- Two space racking height (2.6") / Tray Depth - 12.5"
- Includes 10-32 and 12-24 mounting screws
- Load capacity – 40 lbs
- Black powder coat finish

**ER-S1UV** *Vented One Space Rack Shelf*

- Fits components up to 17.375" wide
- One space rack height (1.75")
- Tray depth – 14.75"
- Convenient tie down slots in rear of tray
- Includes 10-32 and 12-24 rack screws
- Load capacity – 50 lbs
- Black static resistant powder coat finish

**ER-S2U** *Two Space Rack Shelf*

- Fits components up to 17.375" wide
- Two space racking height (3.5")
- Tray depth – 14.75"
- Convenient tie down slots in rear of tray
- Includes 10-32 and 12-24 mounting screws
- Load capacity – 50 lbs
- Black static resistant powder coat finish

**ER-S2UV** *Vented Two Space Rack Shelf*

- Fits components up to 17.375" wide
- Two space racking height (3.5")
- Tray depth – 14.75"
- Convenient tie down slots in rear of tray
- Includes 10-32 and 12-24 mounting screws
- Load capacity – 50 lbs
- Black static resistant powder coat finish



# Equipment Racks & Accessories

## Shelves

Flat Panel Mounts Digital Signage Mounts Projector Mounts **Equipment Racks & Accessories** Security Mounts Satellite & Antenna Mounts DLP Mounts & Turntables Speaker Stands

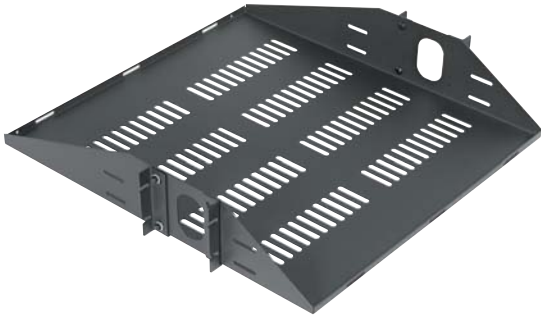

### ER-S2CM *Vented Two Space Center Mount Rack Shelf*

- Fits components up to 17.375" wide
- Two space racking height (3.5")
- Tray depth – 19"
- Convenient tie down slots in front and rear of tray
- Includes 10-32 and 12-24 mounting screws
- Load capacity – 50 lbs
- Black static resistant powder coat finish



### ER-8RSA *Adjustable Eight Receiver Rack Shelf*

- Accommodates up to eight receivers
- Adjusts left to right and front to back
- Includes front and top anti-roll bars
- Includes 10-32 and 12-24 mounting screws
- Load capacity – 50 lbs
- Black powder coat finish
- US Patent #: 7,850,022

#### Additional Parts



*Additional Parts Include: Front and top anti-roll bars and additional receiver separators.*



### ER-SS1U *Rack Mounted Sliding Shelf – 1 Space*

- Closes flush when not in use
- Shelf "locks" into place when fully closed to prevent drifting
- Maximum extension – 13.8"
- Tray dimension – 16.3" W x 13.8" D x 1.75" H (1 RU)
- Includes 10-32 and 12-24 mounting screws
- Load capacity – 35 lbs
- Black static resistant powder coat finish



### ER-S1U4P

#### *Vented One Space Adjustable Four Post Rack Shelf*

- Fits components up to 16.85" wide (17.4" when shelf is flipped over)
- One space rack height (1.75")
- Tray depth adjustable from 14.75" to 25"
- Includes 10-32 and 12-24 mounting screws
- Load capacity – 200 lbs
- Black static resistant powder coat finish



### ER-LCD1017 *LCD Monitor Rack Mount*

- Holds monitors 10" – 17" / 9 space racking height
- Can be inverted to hold monitors up to 23"
- Recesses monitor into rack
- Accommodates monitors with 75mm and 100mm VESA hole patterns
- Includes 10-32 and 12-24 rack screws
- Load capacity - 50 lbs
- Black static resistant powder coat finish



## Equipment Rack Accessories

### ER-HWB1 *Hinged Wall Bracket – 1 Space*

- Provides easy access to the back of mounted components
- Right or left hand opening / 4" depth
- Includes 10-32 and 12-24 mounting screws
- Black powder coat finish



### ER-HWB2 *Hinged Wall Bracket – 2 Space*

- Provides easy access to the back of mounted components
- Right or left hand opening / 4" depth
- Includes 10-32 and 12-24 mounting screws
- Black powder coat finish

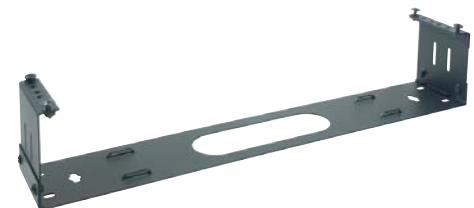

# Equipment Racks & Accessories

## Accessories

Flat Panel Mounts Digital Signage Mounts Projector Mounts **Equipment Racks & Accessories** Security Mounts Satellite & Antenna Mounts DLP Mounts & Turntables Speaker Stands



### ER-DRCM1 *D-Ring Cable Manager – 1 Space*

- Large slotted metal rings manage all types and sizes of wire and cable
- Easy to install on equipment racks
- Includes 10-32 and 12-24 mounting screws
- Black powder coat finish



### ER-DRCM2 *D-Ring Cable Manager – 2 Space*

- Large slotted metal rings manage all types and sizes of wire and cable
- Easy to install on equipment racks
- Includes 10-32 and 12-24 mounting screws
- Black powder coat finish



### ER-CASTERS *Rack Casters*

- Heavy duty casters that attach to the ER-1, ER-148 or ER-184
- Set includes 4 casters
- Hole pattern – 2.375" x 3.375"
- Hardware to attach casters to rack included
- Maximum weight capacity of rack with casters – 400 lbs



### VMP-VWS *Vented Wall Shelf*

- Internal dimensions - 20.5" W x 17" D x 17" H
- Convenient quick-slide assembly
- Five cable supply locations
- Wall or backboard mount
- Load capacity - 200 lbs
- Black static resistant powder coat finish

**DVR-LB3** *Low Profile DVR / Storage Lockbox*

- Interior dimensions 17.2" W x 21" D x 5" H
- Rack mountable on 2 or 4 posts with a 3 RU overall height
- Multiple vents with removable vent blockers for active or passive thermal management
- Single fan included with mounting location for second fan
- Interlocking lift off lid
- Key locked hinged front door
- Black static resistant powder coat finish

**ER-1B** *Single Space Blank Panel (1.75") (Shown Top)*

- Tempered 16 gauge steel with black static resistant powder coat finish

**ER-2B** *Two space rack filler (3.5") (Shown Middle)*

**ER-4B** *Four space rack filler (7") (Shown Bottom)*

**ER-8B** *Eight space rack filler (14") - (Not Shown)*

**ER-RS1032-50** *Rack Screws*

- 50 screws - 0.75" long with 10 – 32 threads
- Classic Phillips trim head
- Heat treated to resist stripping
- Includes nylon washers

**ER-RS1032-100** *Same as above in 100 pack*





### **DVR-LB3** *Low Profile DVR / Storage Lockbox*

- Interior dimensions 17.2" W x 21" D x 5" H
- Rack mountable on 2 or 4 posts with a 3 RU overall height / Interlocking lift off lid
- Multiple vents with removable vent blockers for active or passive thermal management
- Single fan included with mounting location for second fan / Key locked hinged front door
- Black static resistant powder coat finish



### **DVR-LB1** *DVR Lockbox*

- Interior dimensions 21" W x 21" D x 8" H
- Vented and includes fan for additional thermal management / Interlocking lift off lid
- Key locked hinged front door
- Black static resistant powder coat finish



### **DVR-LB2** *DVR Lockbox With Smoked Plexiglas® Window*

- Interior dimensions 21" W x 21" D x 8" H
- Window dimensions are 18" W x 3" H
- Window will pass IR signals
- Vented and includes fan for additional thermal management / Interlocking lift off lid
- Key locked hinged front door
- Black static resistant powder coat finish



### **DVR-MB1** *Mobile/Rackmount DVR Lockbox*

- Interior dimensions 17" W x 13.8" D x 3" H
- Lockbox is mountable on 4 sides for mobile applications or rack mountable with a 2U overall height
- Securing strips included for DVR in mobile applications
- Removable lid secured with tamper proof hardware
- Single fan included and mounting locations for up to four fans / Key locked hinged front door
- Multiple vents with removable vent blockers for active or passive thermal management
- Black static resistant powder coat finish



## DVR-WA *DVR Lockbox Wall Mounting Arms*

- Works with the DVR-LB1 and DVR-LB2 to mount lockbox to 16" on center studs
- Load capacity – 50 lbs
- Black static resistant powder coat finish



## LCD-PV *Public View LCD Monitor Mount Kit*

### *Kit Includes:*

#### **LCD-2537CB** *Mid-Size Flat Panel Ceiling Mount*

- Holds 10" – 37" LCD monitors
- Modified with two mounting points for camera bracket
- Rotates 360° / Adjustable tilt -5° to +20°
- Mast telescopes 18" – 30"
- Load capacity - 75 lbs / Black powder coat finish

#### **AK-1PT & CP-1PT** *Adaptor Kit & Ceiling Plate*

- Used together, these units allow ceiling to mount extension drop distances of almost any length using standard 1.5" NPT pipe

#### **Universal Camera Bracket**

- Can be assembled into several different configurations
- Industry standard ¼" – 20 UNC threading



### Parts Provided



\*Camera Not Included

## PMC-S *Small Projector Enclosure*

- Inner dimensions - 16"W x 16"D x 10"H
- Lift off lid for installation / Utilizes tamper resistant screws
- Easy access hinge for maintenance
- Adjustable front security bars for lens placement
- Accommodates PM-2, PM-3B and PM-LPB
- Black powder coat finish

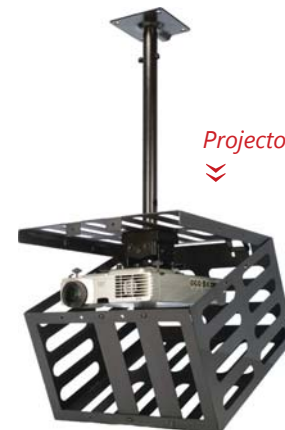

Projector not included



## PMC-L *Large Projector Enclosure*

- Inner dimensions - 24"W x 20"D x 13"H
- Lift off lid for installation / Utilizes tamper resistant screws
- Easy access hinge for maintenance
- Adjustable front security bars for lens placement
- Accommodates PM-1, PM-3B and PM-LPB
- Black powder coat finish



# Mounting Accessories

Flat Panel Mounts Digital Signage Mounts Projector Mounts Equipment Racks & Accessories Security Mounts Satellite & Antenna Mounts DLP Mounts & Turntables Speaker Stands

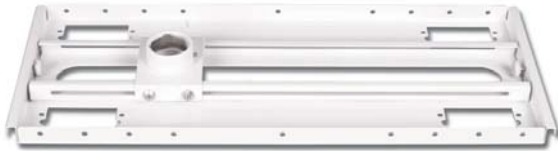

## SCM-1 *Suspended Ceiling Adaptor*

- For use with 2' x 2' or 2' x 4' suspended ceiling grids
- Can be used with standard 1.5" NPT pipe or VMP ceiling masts
- Includes 20 feet of tie wire
- Four integrated standard electrical KOs
- Load capacity - 75lbs / White powder coat finish

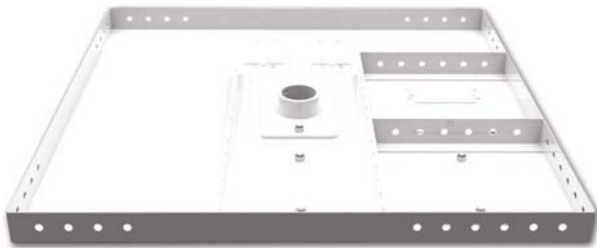

## SCM-2 *Suspended Ceiling Replacement Tile*

- For use with 2' x 2' or 2' x 4' suspended ceiling grid
- Ceiling tile can be rotated for 9 possible mounting locations
- Can be used with standard 1.5" NPT pipe or VMP ceiling masts
- Includes 30 feet of tie wire
- Four integrated standard electrical KOs
- Load capacity - 200lbs / White powder coat finish



## CP-1 *Ceiling Plate For Standard 1.5" NPT Pipe*

- Universal ceiling flange works with all manufacturers' mounting systems when using standard 1.5" NPT pipe
- Provides base for ceiling installations
- Black powder coat finish

**CP-2** *Same as above except for use with 1" NPT pipe*



## CP-1PT

### *Ceiling Plate For Standard 1.5" NPT Pipe With Cable Pass-Through*

- Universal ceiling flange works with all manufacturers' mounting systems when using standard 1.5" NPT pipe
- Cable pass-through for easy cable management
- Provides base for ceiling installations
- Black powder coat finish

## AK-1 *Adaptor Kit To Convert To 1.5" NPT Pipe*

- Adaptor Kit for, PM Series and LCD-2537CB to enable use with standard 1.5" NPT pipe
- Black powder coat finish

**AK-2** *Adaptor Kit for VMP042/044, VMP046/048, and LCD-1CB to enable use with standard 1" NPT pipe*



## AK-1PT

*Adaptor Kit To Convert To 1.5" NPT Pipe With Cable Pass-Through*

- Adaptor Kit for the PM Series, LCD-1CB and LCD-2537CB to enable use with standard 1.5" NPT pipe
- Cable pass-through allows cable management through center of masting



## CCA-1 *Cathedral Ceiling Adaptor*

- Designed for angled ceiling installations and works with all manufacturers' mounting systems when using standard 1.5" NPT pipe
- Black powder coat finish



## IBA-1 *I-Beam Adaptor*

- Adapts ceiling mounts to clamp to an I-Beam
- Works with all manufacturers' mounting systems when using 1.5" NPT pipe
- Accommodates 2.25" to 12" flange widths
- Accommodates maximum flange height of 1"
- Black powder coat finish



# Mounting Accessories

Flat Panel Mounts Digital Signage Mounts Projector Mounts Equipment Racks & Accessories Security Mounts Satellite & Antenna Mounts DLP Mounts & Turntables Speaker Stands



## UA-1 *Unistrut® Adaptor*



- Adapts ceiling mounts to work with Unistrut® up to 1.625"
- Works with all manufacturers' mounting systems when using 1.5" NPT pipe
- Black powder coat finish



## EXT-A *Extension Pipe*



- Acts as an inline splice to extend drop length of LCD-2537CB and PM Series (except PM-LPB) by up to 28" (can be cut to length)
- 31" tempered steel mast / Black powder coat finish

**EXT-B** *Same as above except works with VMP042/044, VMP046/048 and LCD-1CB*



## EXT-1830 *1.5" NPT Telescoping Extension – 18" to 30"*



- Works with any manufacturers' ceiling mounts which use 1.5" NPT pipe
- Works with VMP ceiling mounts that have been adapted to use 1.5" NPT pipe
- Adjustable from 18" to 30" / Black powder coat finish

**EXT-4872** *Same as above except adjustable from 48" to 72"*  
**EXT-0609** *Same as above except adjustable from 6" to 9"*



## SCFR-1 *Suspended Ceiling Finishing Ring Kit*



- Finishing ring to clamp around 1.5" NPT pipe
- Includes an adaptor for VMP ceiling masts that are not 1.5" NPT pipe / Chrome finish

## VMP-STRAP *Safety/Security Strap*

- 1" width by 10' length / Sturdy woven nylon blend construction
- Saw tooth cinching buckle / Black, white or silver (specify color)



### CH-001B *Wall Mount Electronic Component Shelf*

- Can be used for holding a single device or "stacked" for multiple components such as DVD players, CD players, DVRs, and HD receivers
- Shelf dimensions – 13" W x 11" D
- Black tempered glass shelf
- Can be used in conjunction with any TV wall mount to design an entertainment center
- Load capacity – 25 lbs / Black powder coat finish



### VH-003 *Wall Mount Electronic Component Holder*

- Can be used for holding a single device or "stacked" for multiple components such as DVD players, CD players, DVRs, and HD receivers
- Mounting ring extends 12" from the wall
- Can be used in conjunction with any TV wall mount to design an entertainment center
- Load capacity – 25 lbs / Black powder coat finish



**VH-003S** *Same as above except silver finish*

### VH-005B *Pipe/Ceiling Mast Electronic Component Holder*

- Works with all manufacturers' ceiling mounts using masting from 1" to 2" O.D.
- Accommodates DVD players, CD players, DVR's, HD receivers, and other electronic components
- Includes decorative plastic covers (not shown)
- Mounting "U" tray extends 13" from the pipe
- Load capacity – 25 lbs / Black powder coat finish



<< Pipe not included

**VH-005** *Same as above except silver finish*

### VH-001 *DVD/DVR/Satellite Receiver Holder*

- Holds DVD players, satellite receivers and DVRs
- Opens 1.83" to 5.25" (top to bottom)
- Opens 10.4" to 17.125" (left to right)
- Height: 5.875" (inside to inside) / Black powder coat finish



**VH-001S** *Same as above except silver finish*

# Mounting Accessories

Flat Panel Mounts   Digital Signage Mounts   Projector Mounts   Equipment Racks & Accessories   Security Mounts   Satellite & Antenna Mounts   DLP Mounts & Turntables   Speaker Stands



Shown with LCD-1C and VH-001S (not included)

## VH-004 *Flat Panel Ceiling Mount Adaptor For VH-001*

- Allows VH-001 to be hung below VMP's flat panel ceiling mounts
- Drop adjustment of 6" to 17"
- Silver powder coat finish

**VH-004B** *Same as above except black finish*

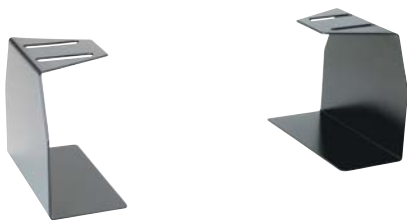

## VH-002 *Add On Holder For VH-001B*

- Allows a second device (DVD player, satellite receiver, digital cable box) to be attached to the VH-001
- Black powder coat finish



## AP-1B *400mm x 200mm VESA Adaptor Plate*

- Adapts a VESA 200mm plate to accommodate a VESA 400mm x 200mm hole pattern
- Black powder coat finish

**AP-1** *Same as above except with silver finish*



## AP-2B *300mm x 300mm VESA Adaptor Plate*

- Adapts a VESA 200mm plate to accommodate a VESA 300mm x 300mm hole pattern
- Black powder coat finish

## AR-1B *Portrait Mounting Adaptor Rails*

- Adapts a wide variety of mounting rails to accept a maximum of 650mm vertical hole patterns
- Black powder coat finish

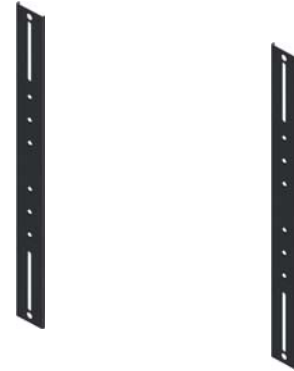

## IWB-1B *In Wall Box or Adaptor*

- Can be used as a pre-construction or retro-fit in wall box or in conjunction with the LCD-1B or the LCD-2537B for a "No Profile" flat panel installation
- Holds 15"– 32" flat panels
- Installs between 16" centers
- Integrated cable (4) and electrical knockouts (2)
- Includes black adaptors for the LCD-1B and LCD-2537B
- Load capacity – 50 lbs

**IWB-1** *Same as above except with silver adaptors*



*Shown with LCD-2537B  
(not included)*

*Versatile in wall box*



## LCD-PA *Pole Adaptor*

- For use with LCD-1 and LCD-2537
- Adapts round or square poles to accept mount
- Stainless steel straps adjust from 4" – 10"
- Silver powder coat finish



## LVMP-1 *Low Voltage Mounting Plate*

- Eliminates the need for an electrical junction box
- Perfect for low voltage class 2 wiring
- Works with ½" – 1¼" walls
- Installs with a screwdriver and a drywall saw
- Mounts any standard low voltage device
- Mounting screws included

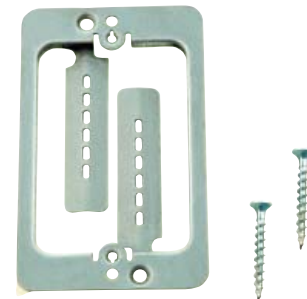

# Satellite Equipment & Accessories

Flat Panel Mounts Digital Signage Mounts Projector Mounts Equipment Racks & Accessories Security Mounts **Satellite & Antenna Mounts** DLP Mounts & Turntables Speaker Stands



## FRM Series *Non-Penetrating Roof Mounts*

- Non-penetrating roof mounts are constructed of steel and use standard concrete blocks to anchor.
- For use with DBS, off-air antenna, satellite internet systems, and point to point CCTV signal transmission
- Dark gray weather resistant powder coat finish

**FRM-125** 60" mast with 1.25" O.D.

**FRM-166** 30" mast with 1.66" O.D.

**FRM-200** 30" mast with 2" O.D.

**FRM-MAT** Rubber Mat (Placed under mount)



## FRMA *Adaptor For FRM Mounts*

- Adapts FRM-200 mount (2" OD masting) to 2.375" OD masting
- Dark gray weather resistant powder coat finish



## PRM-2 *Non-Penetrating Pitched Roof Mount*

- Accommodates 18" and 24" DBS/DSS dishes
- Holds up to eleven 8" x 8" x 16" standard concrete blocks to anchor or comes with pitch pad kit
- Adjustable dish mounting plate
- Heavy duty steel construction
- Dark gray weather resistant powder coat finish



## TR Series *Heavy Duty Tripods*

- Tripods hold masts up to 1.75" OD
- Includes a pitch pad kit, a universal mast clamp and has installer friendly front facing feet

**TR-36** 36" heavy duty tripod

**TR-60** 60" heavy duty tripod



## WB-6 6" Wall Mount

- "U" bolt mast holder with 6" clearance
- Accommodates 1.25" to 1.66" antenna or DBS pipe
- Sold in pairs



## BR-4XD Heavy Duty 4" Wall Mount

- Accommodates 1" to 2.25" antenna or DBS pipe
- 3" clearance
- Sold in pairs

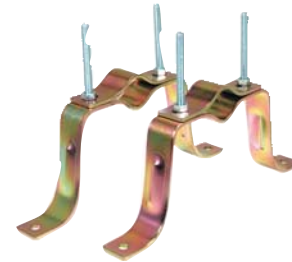

## P-6 Vent Pipe Mount

- Mounting attachment for vent pipes 2.75" to 5" O.D.
- Accommodates 1" to 2" antenna or DBS pipe
- Sold in pairs

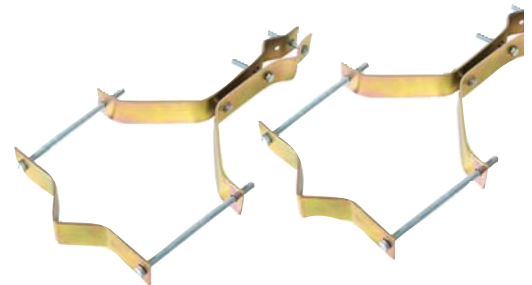

## Y-MOUNT "Y" Type Chimney Mount

- Accommodates 1.25" to 1.66" antenna or DBS pipe
- Includes 0.75" by 18' anodized steel straps
- Sold in pairs



## Z-MOUNT "Z" Type Chimney Mount

- Accommodates 1.25" to 1.66" antenna or DBS pipe
- Includes 0.75" by 18' anodized steel straps
- Sold in pairs



# Satellite Equipment & Accessories

Flat Panel Mounts   Digital Signage Mounts   Projector Mounts   Equipment Racks & Accessories   Security Mounts   **Satellite & Antenna Mounts**   DLP Mounts & Turntables   Speaker Stands



## **GEM-4060** *Adjustable Gable End Antenna Mount*



- Mounting bracket adjusts from 40" to 60" (left to right)
- Holds up to a 1.5" antenna mast



## **GEM-1** *DBS Gable Mount*



- Accommodates the mounting of a DBS dish on a gable end or eve
- Adjustable -  $\pm 45^\circ$

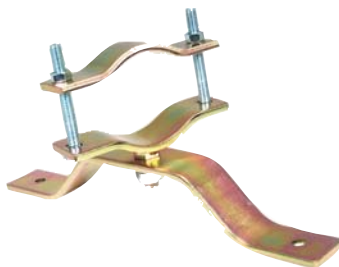

## **GU-3** *Swivel Bracket*



- Wall bracket mounts antenna or DBS pipe 3" off wall
- Accommodates 1.25" to 3" antenna or DBS pipe



## **SM-1** *DBS Siding Mount*



- Accommodates the mounting of a DBS dish on house siding and creates a flat mounting platform for the DBS foot plate by nesting against the siding
- Constructed of heavy duty "DBS gray" plastic



## **ER-1** *19" Headend Equipment Rack - 71" Height*



- Rail height - 71"
- 40 rack spaces
- EIA compliant
- Standard 10-32 threading
- Includes 32 rack screws
- Steel construction
- Load capacity - 400 lbs evenly distributed
- Black static resistant powder coat finish

## ER-S1 *Economy Rack Shelf*

- Fits components up to 17" wide
- Two space racking height (2.6")
- 12.5" tray depth
- Includes 10-32 and 12-24 mounting screws
- Load capacity – 40 lbs / Black powder coat finish



## ER-S1V *Vented Economy Rack Shelf*

- Fits components up to 17" wide
- Two space racking height (2.6")
- Tray Depth - 12.5"
- Includes 10-32 and 12-24 mounting screws
- Load capacity – 40 lbs
- Black powder coat finish



## ER-8RSA *Adjustable Eight Receiver Rack Shelf*

- Accommodates up to eight receivers
- Adjusts left to right and front to back
- Includes front and top anti-roll bars
- Includes 10-32 and 12-24 mounting screws
- Load capacity – 50 lbs
- Black powder coat finish
- US Patent #: 7,850,022

*Additional Parts Include: Front and top anti-roll bars and additional receiver separators.*



Additional Parts



## ER-SS1U *Rack Mounted Sliding Shelf – 1 Space*

- Closes flush when not in use / Shelf "locks" into place when fully closed to prevent drifting
- Maximum extension – 13.8"
- Tray dimension – 16.3" W x 13.8" D x 1.75" H (1 RU)
- Includes 10-32 and 12-24 mounting screws
- Load capacity – 35 lbs
- Black static resistant powder coat finish



# DLP Mounts & Turntables

Flat Panel Mounts Digital Signage Mounts Projector Mounts Equipment Racks & Accessories Security Mounts Satellite & Antenna Mounts **DLP Mounts & Turntables** Speaker Stands



## DLP-2 *DLP Television Wall Mount*

- Unique 3 bracket system provides under and/or over mounting for DLP TVs
- Adjusts from 14" – 20" front to back
- Includes anti-skid pads
- Low profile hideaway design
- Load capacity – 125 lbs
- Black powder coat finish



## TT-Series *Television/Flat Panel Turntable Series*

### TT-13 *Small Television/Flat Panel Turntable*

- Platform width 15" / depth 12"
- Load capacity – 60 lbs

### TT-20 *Medium Television/Flat Panel Turntable*

- Platform width 20" / depth 15"
- Load capacity – 75 lbs

### TT-27 *Large Television/Flat Panel Turntable*

- Platform width 26" / depth 16"
- Load capacity – 125 lbs

### TT-32 *Mega Television/Flat Panel Turntable*

- Platform width 32" / depth 18"
- Load capacity – 200 lbs



## TT-LCD20B *Flat Panel Turntable*

- Platform width 20" / depth 14"
- Load capacity – 75 lbs
- Black finish

**TT-LCD20S** *Same as above except with silver finish*



## SP-200W *Multi-Configurable Speaker Mount*

- Virtually limitless number of configurations for the wall or ceiling and full range of tilt, twist and swivel
- Mounts on back of speaker
- Load capacity - 12 lbs
- High impact plastic / White finish / Sold in pairs

**SP-200B** *Same as above except with black finish*



## SP-001 *Speaker Wall/Ceiling Mount*

- Swivels 180° / Twists 180°
- Load capacity – 10 lbs
- Black powder coat finish / Sold in pairs



## SP-007 *Speaker Wall Mount*

- Swivels 180° / Plate size 6" x 6"
- Load capacity – 12 lbs
- Black powder coat finish / Sold in pairs



## SP-010 *Adjustable Speaker Wall Mount*

- Adjusts to fit 7" to 12" depth speakers
- Swivels 135° / Adjustable tilt 0° to 20°
- Load capacity – 20 lbs
- Black powder coat finish / Sold in pairs



## SP-013 *Speaker Wall Mount*

- Swivels 135° / Adjustable tilt 0° to 20°
- Plate size – 6" x 6" / Sold in pairs
- Load capacity – 10 lbs / Black powder coat finish



## RESOURCES

---



### Subscribe to our Monthly Newsletter..

Its EASY! Scan this code or visit us online and learn about the latest in mounting technology, special tradeshow give-aways, and more about what's going on at VMP!



**Our staff is your number one resource.**

Call our toll free line and speak directly to one of our team members:  
**877.281.2169**



**On the go?**

Download the VideoMount Finder™ app for your iPhone, Blackberry or Android at:  
**www.videomount.com**



**Need help choosing the right mount for your application?**

Check out this innovative tool at:  
**www.chooseamount.com**



**Find us on Facebook!**

Find us on Facebook, and stay up to date with new products, what shows you can visit us at, and much more.



Video Mount Products is an active member of INFOCOMM iQ.  
Join VMP at: <http://catalogs.infocommiq.com>

## NOTES

---

---

---

---

---

---

---

---

<b>A</b>		<b>E cont'd</b>		<b>L</b>		<b>S</b>	
AK-1	31	ER-S1	22,39	LCD-1	9	SCFR-1	32
AK-IPT	31	ER-SIU4P	25	LCD-1B	9	SCM-1	30
AK-2	31	ER-SIUUV	23	LCD-1C	11	SCM-2	30
AP-1	14,34	ER-SIV	22,39	LCD-1CB	11	SM-1	38
AP-1B	14,34	ER-S2CM	24	LCD-1CW	11	SP-001	41
AP-2B	15,34	ER-S2U	23	LCD-2	12	SP-007	41
AR-1B	15,35	ER-S2UV	23	LCD-2B	12	SP-010	41
		ER-SSIU	24,39	LCD-2537	9	SP-013	41
		ER-W24	21	LCD-2537B	9	SP-200W	41
<b>B</b>		EXT-0609	32	LCD-2537C	11	SP-200B	41
BR-4XD	37	EXT-1830	32	LCD-2537CB	11		
		EXT-4872	32	LCD-CM2	13	<b>T</b>	
<b>C</b>		EXT-A	32	LCD-DM2	14	TR-Series	36
CCA-1	31	EXT-B	32	LCD-MID-C	10,17	TR-36	36
CH-001B	33			LCD-MID-CB	10,17	TR-60	36
CP-1	30	<b>F</b>		LCD-MID-CHB	10	TT-13	40
CP-IPT	30	FP-LDSB	6,16	LCD-MID-CM2	13,17	TT-20	40
CP-2	30	FP-LF	4	LCD-MID-CM2B	13,17	TT-27	40
		FP-LFB	4	LCD-MID-F	5	TT-32	40
<b>D</b>		FP-LFV	4	LCD-MID-FB	5	TT-LCD20B	12,40
DLP-2	40	FP-LFVB	4	LCD-MID-FT	7	TT-LCD20S	12,40
DS-BP	16	FP-MF	5	LCD-MID-FTB	7		
DS-CH	16	FP-MFB	5	LCD-PA	15,35	<b>U</b>	
DVR-LB1	28	FP-MFTB	7	LCD-PV	29	UA-1	32
DVR-LB2	28	FP-MWAB	8	LCD-UC1	12		
DVR-LB3	27,28	FP-SFB	5	LCD-WM2	14	<b>V</b>	
DVR-MB1	28	FP-SFT	7	LVMP-1	35	VH-001	33
DVR-WA	29	FP-SFTB	7			VH-001S	33
		FP-XMF	4	<b>P</b>		VH-002	34
<b>E</b>		FP-XMFB	4	P-6	37	VH-003	33
ER-1	20,38	FP-XMFT	6	PDS-LC	10,16	VH-003S	33
ER-148	20	FP-XMFTB	6	PDS-LCB	10,16	VH-004	34
ER-1-4PKIT	20	FP-XMWAB	8	PDS-LCM2B	13,17	VH-004B	34
ER-1B4	21	FRMA	36	PDS-LFT	6	VH-005	33
ER-1B4-4PKIT	21	FRM-MAT	36	PDS-LFTB	6	VH-005B	33
ER-1B	27	FRM-Series	36	PDS-LWA	8	VMP-STRAP	32
ER-2B	27	FRM-125	36	PDS-LWAB	8	VMP-VWS	26
ER-4B	27	FRM-166	36	PM-1	19		
ER-8B	27	FRM-200	36	PM-2	19	<b>W</b>	
ER-72	22			PM-3	18	WB-6	37
ER-84	22	<b>G</b>		PM-3B	18		
ER-BRSA	24,39	GEM-1	38	PMC-L	19,29	<b>Y</b>	
ER-CASTERS	26	GEM-4060	38	PMC-S	19,29	Y-MOUNT	37
ER-DRCM1	26	GU-3	38	PM-LP	18		
ER-DRCM2	26			PM-LPB	18	<b>Z</b>	
ER-HWB1	25	<b>I</b>		PM-LPM	18	Z-MOUNT	37
ER-HWB2	25	IBA-1	31	PM-LPMB	18		
ER-LCD1017	12,25	IWB-1	15,35	PRM-2	36		
ER-RS1032-50	27	IWB-1B	15,35				
ER-RS1032-100	27						

Satellite & Antenna Mounts Flat Panel Mounts Digital Signage Mounts Projector Mounts Equipment Racks & Accessories



**VIDEO MOUNT PRODUCTS**  
345 LOG CANOE CIRCLE STEVENSVILLE, MD 21666  
TOLL FREE 877.281.2169 TELEPHONE 410.643.6390 FACSIMILE 410.643.6615  
[WWW.VIDEOMOUNT.COM](http://WWW.VIDEOMOUNT.COM) | [WWW.CHOOSEAMOUNT.COM](http://WWW.CHOOSEAMOUNT.COM)